

CONTROL PANEL

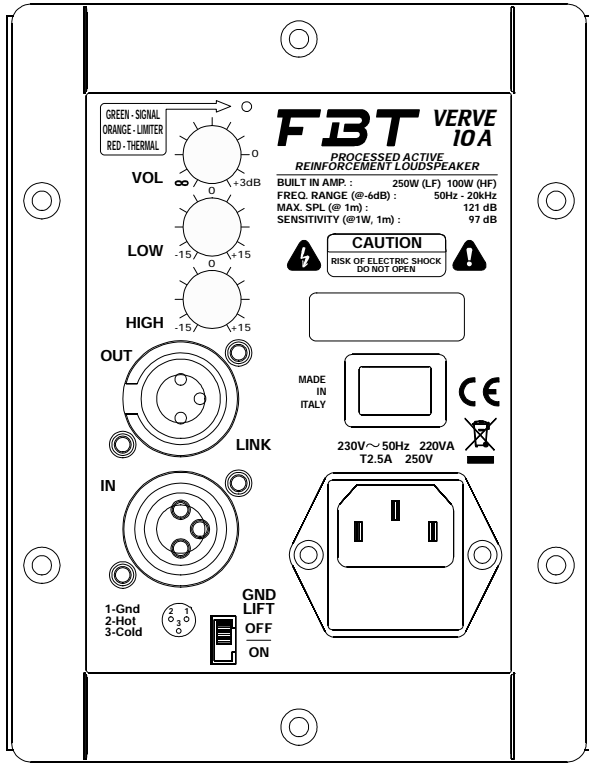

DIMENSIONAL DRAWING

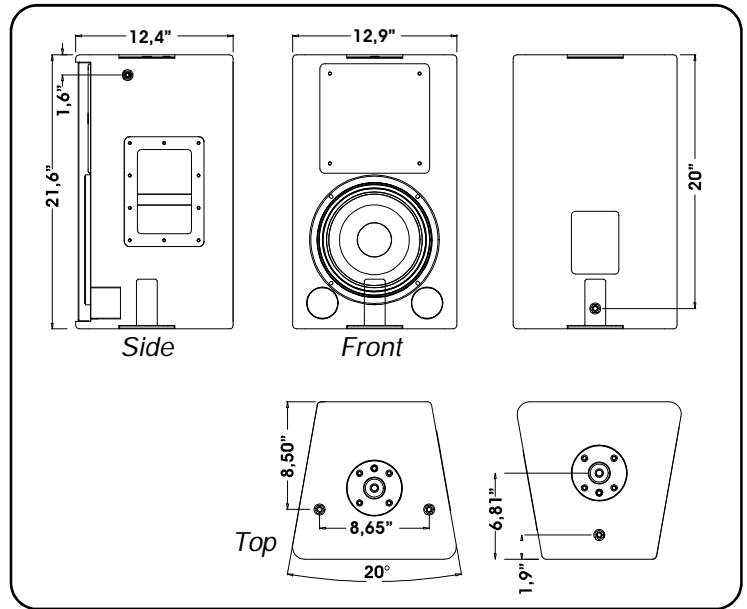

ACCESSORIES



BOX 120
Directional wall
mount

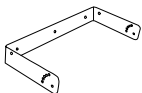

BOX 114
Mount for
horizontal
wall installation

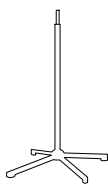

SS2
Standard speaker
stand

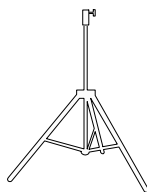

BOX 32BK
Adjustable aluminum
speaker stand, damped
safety mechanism

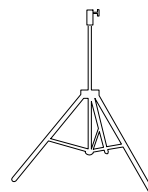

BOX 22BK
Adjustable aluminum
speaker stand, 1.38"
with 1" adapter

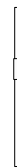

BOX 52BK
Adjustable for
sub-satellite
speaker connection,
with safety locking
device

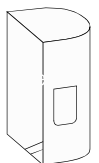

V 46
Carrying Bag