



EvoMaxX 6

Passive Sound Reinforcement Speaker

NEODYMIUM
WOOFER



LIGHTWEIGHT



FLOOR
MONITOR



HARDWARE FOR
PERMANENT
INSTALLATIONS



APPLICATIONS

- Live Sound P.A. System
- Live Sound Monitor
- D.J. System
- School & Corporate Audio Visual Sound Reinforcement
- Background Music/Announcement: Restaurants, Pubs
- Transportation Terminals
- Clubs
- Auditoriums
- Theatres
- Gyms
- Houses of Worship

FEATURES

- Extra Lightweight Polypropylene Cabinet, 46.9 lbs.
- Power Handling: 400W RMS @ 8 Ohms.
- 15" neodymium magnet woofer with 2.5" voice coil custom made for FBT.
- B&C HF compression driver with 1.7" voice coil and 1" exit .
- Input panel with 2 x Neutrik Speakon NL- 4 IN and LINK.
- Two integrated handles and Stage Floor Monitor taper.
- Multiple mounting options: 1.38" top-hat speaker stand socket, wall bracket mount flange plate, four M10 suspension points.
- Optional Carrying Bag available for protection for portable use
- Completely Manufactured in Italy



Designed, Engineered
and Manufactured in ITALY

PRODUCT DESCRIPTION

The **EVOMaxX 6** passive speaker features lightweight, yet rugged gas injected molded polypropylene cabinet construction. The asymmetrical shape of the **EVOMaxX 6** cabinet also allows use as a floor stage monitor. The **EVOMaxX 6** passive speaker is a two way design incorporating a 15" custom made for FBT low frequency woofer with 2.5" voice coil and a 1" throat exit B&C HF compression driver coupled to a 90°H x 60°V constant directivity horn . The internal passive crossover filter with soft/trip protection circuits on woofer and compressor driver is at a fixed frequency of 1.6kHz. With a frequency range of 48Hz-18kHz, the **EVOMaxX 6** provides hi fidelity sound for both speech and music applications with a maximum SPL of 130dB. A front face steel grille protects the woofer from external damage. The rear input panel features 2 Neutrik NL-4 Speakon input and link to allow daisy chaining an additional **EVOMaxX 6** speaker. The four M10 fly points built into the cabinet, along with the optional Box 104/105 mounting brackets allow the **EVOMaxX 6** speakers to be surface mounted on walls or ceilings. A standard 1,38" speaker stand socket allows the **EVOMaxX 6** to be mounted on speaker stands.

ELECTRONIC SPECIFICATIONS

System Type	2 Way
Recommended Amplifier	400W RMS
Long Term Applicable Power (AES)	200W
Short Term Applicable Power (IEC 268-5)	800W
Nominal Impedance	8 Ohm
Frequency Response @ -6dB	48Hz - 18kHz
Sensitivity (@ 1W, 1mt)	99dB
Maximum SPL (continuous/peak)*	126dB / 130dB
Dispersion	90°H x 60°V
Crossover Frequency	1.6kHz
Recommended HP Filter	40Hz - 24dB oct.

PHYSICAL SPECIFICATIONS

Low Frequency Woofer	1 x 15" / 2.5" coil
High Frequency Driver	1" + horn / 1,7" coil
Input Connectors	2 x Speakon NL4
Net Dimensions (WxHxD)	19" x 29.8" x 15.7"
Shipping Dimensions (WxHxD)	23.4" x 34.6 x 20.3"
Net Weight	46.9 lbs
Shipping Weight	55.7 lbs
Enclosure Material	Polypropylene
Grille	Steel with powder coat black paint finish

* CONT. SPL: free space, based on recommended amp rating and LF transducer average sensitivity data, 125mS time average
PEAK SPL: free space, based on short term applicable power rating and system peak sensitivity, 10mS time average



EvoMaxX 6

Passive Sound Reinforcement Speaker

DIAGRAMS

HORIZONTAL (Hz)

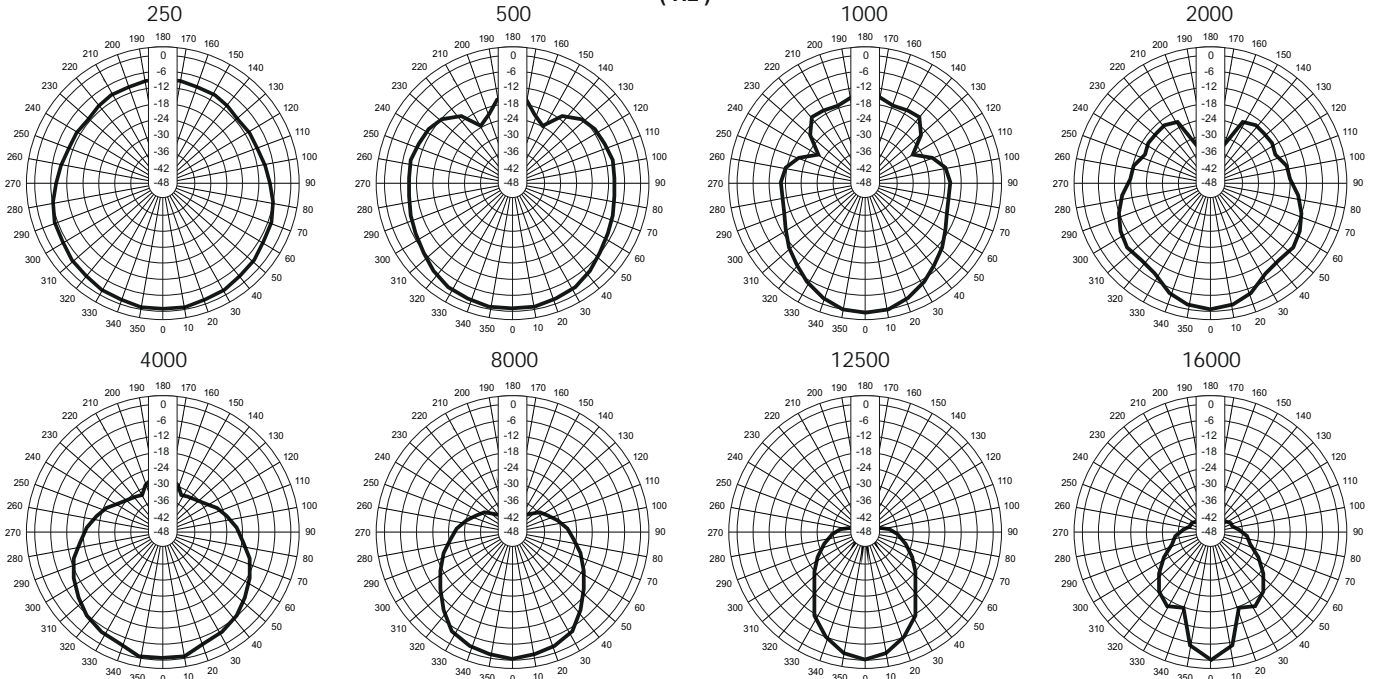

VERTICAL (Hz)

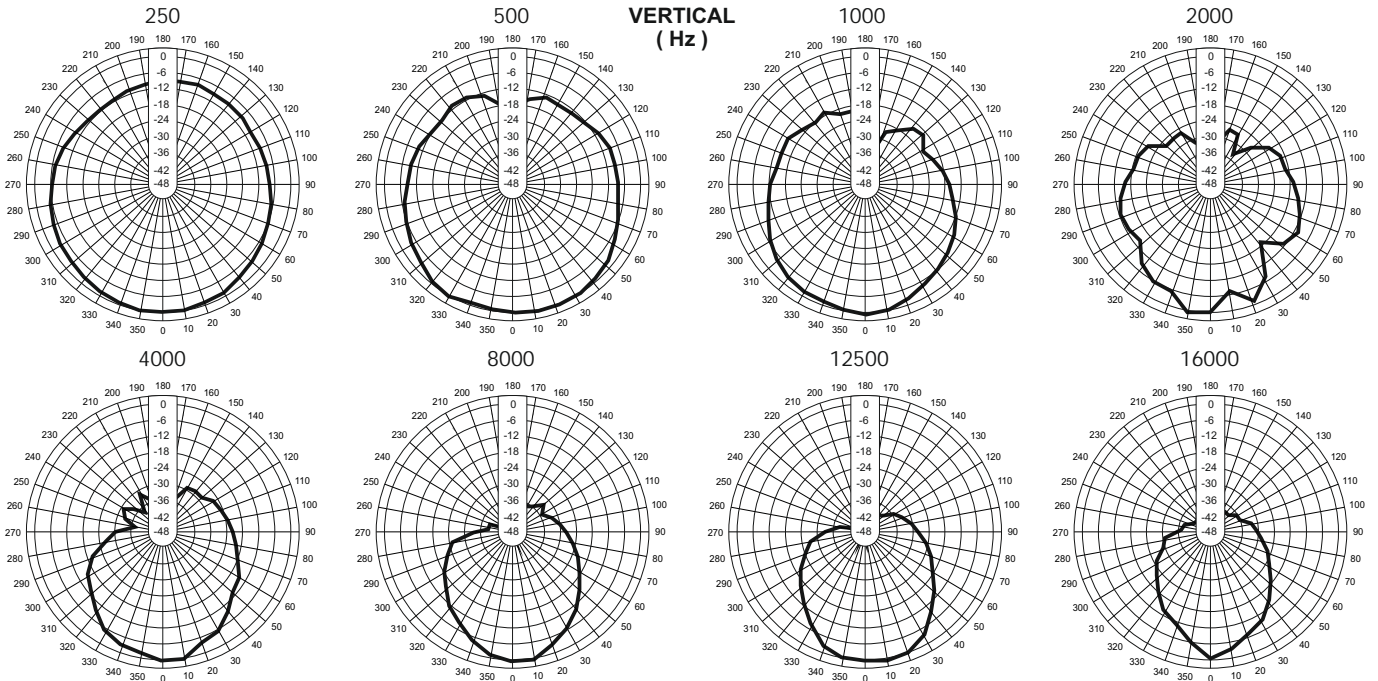

FREQUENCY RESPONSE

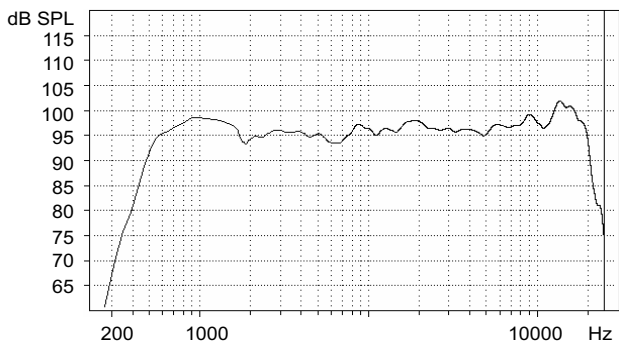

Q factor, Dindex

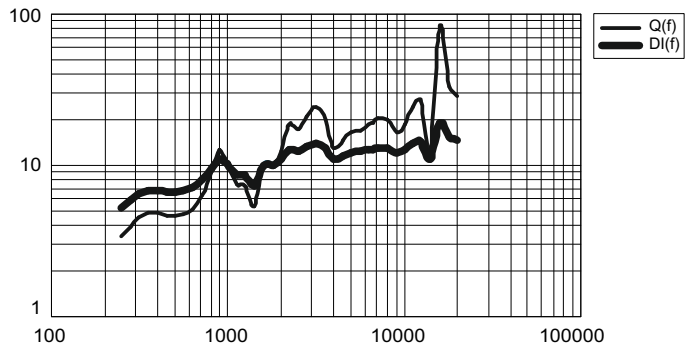



EvoMaxX 6

Passive Sound Reinforcement Speaker

CONTROL PANEL

BLOCK DIAGRAM

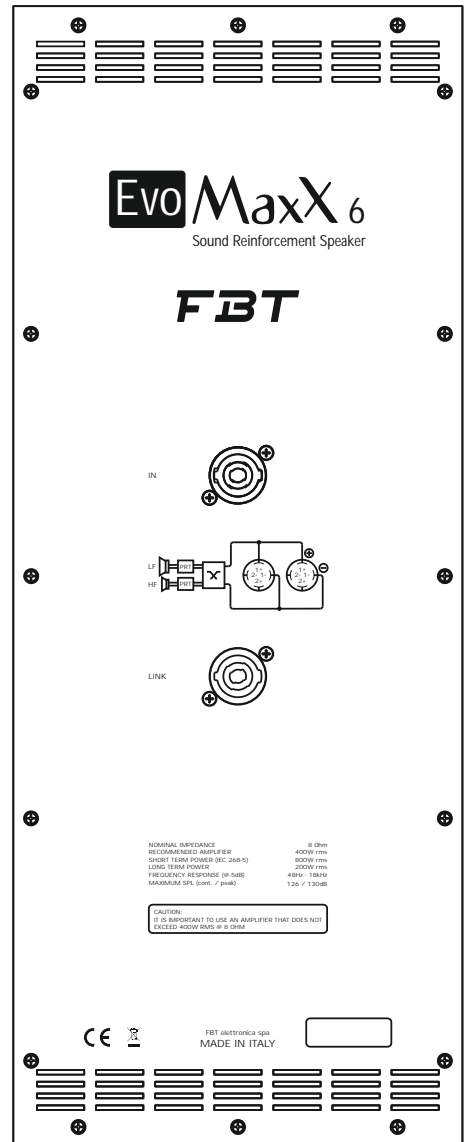
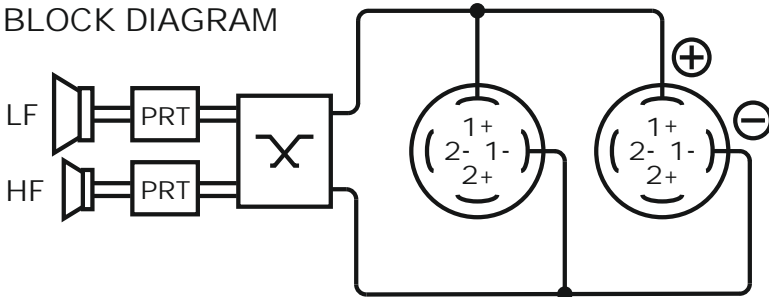

DIMENSIONAL DRAWINGS

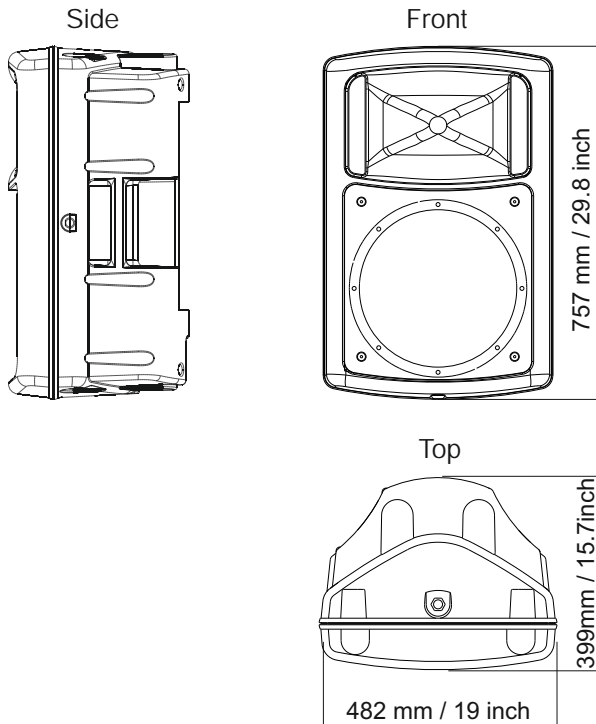

ACCESSORIES

